

# Sequence Injection Controller

INSTRUCTION MANUAL  
TYPE ACT-D800





## Thank you for using YUDO production

### 感谢贵公司使用YUDO产品

Before using the product ,please read this instruction manual carefully to avoid any damage due to improper usage. If you have any questions, please do not hesitate to contact our Head Office or YUDO Territory Sales Branch.

使用本产品前，敬请仔细阅读此手册，以免在操作过程中的失误。如有任何疑问，敬请与柳道公司总部联系或柳道所在地分公司联系。

# Contents

## 目录

1、 Environments .....	2
使用环境	
2、 Composition of Control Module .....	2
PCB 结构	
3、 Central Processing Unit .....	2
主要控制装置	
4、 Input .....	2
输入因素	
5、 Display .....	3
显示因素	
6、 Output .....	3
输出因素	
7、 Start to Run.....	4
使用说明	
8、 Menu Setting.....	5
动态说明	
9、 Mode Specification .....	7
模式规格	
10、 System Application .....	8
系统应用程序	
11、 Wiring Specification.....	9
外部线连接图	

## 1、Environments 使用环境

1) Main Power Input: AC220V (50-60Hz)

启动电源: AC220V/50-60Hz

2) Signal Input Power: DC24V or AC220V

信号输入电源: DC24V or AC220V

3) Solenoid Valve Output Power: DC24V(Less than 100mA per GATE) or AC220V(Total less than 1A)

螺旋管针阀输出电源: DC24V(每GATE100mA以下) 或者AC220V(1A以下)。

## 2、Composition of Control Module PCB构成

1) **CONTROL PCB**: Power unit, MICOM, Input/output unit

控制器PCB: 电源部, MICOM, 输入输出部。

2) **DISPLAY PCB** : Display unit Switch.

显示器PCB: 显示部, 开关输入部。

## 3、Central Processing Unit 主要控制装置

1) **S.M.P.S** <sup>①</sup> : To transform input AC220V to DC24V/1A,DC5V/1A.

S.M.P.S: 把AC220V电源转换成内部驱动电源DC24V/1A,DC5V/1A。

2) **M.P.U** : To control input/output and display.

微处理器: 输出控制及显示器控制。



3) **RELAY** : Solenoid Valve running element (DC24V or AC220V output).

继电器: 螺旋管针阀驱动元件(DC24V或者AC220V输出)

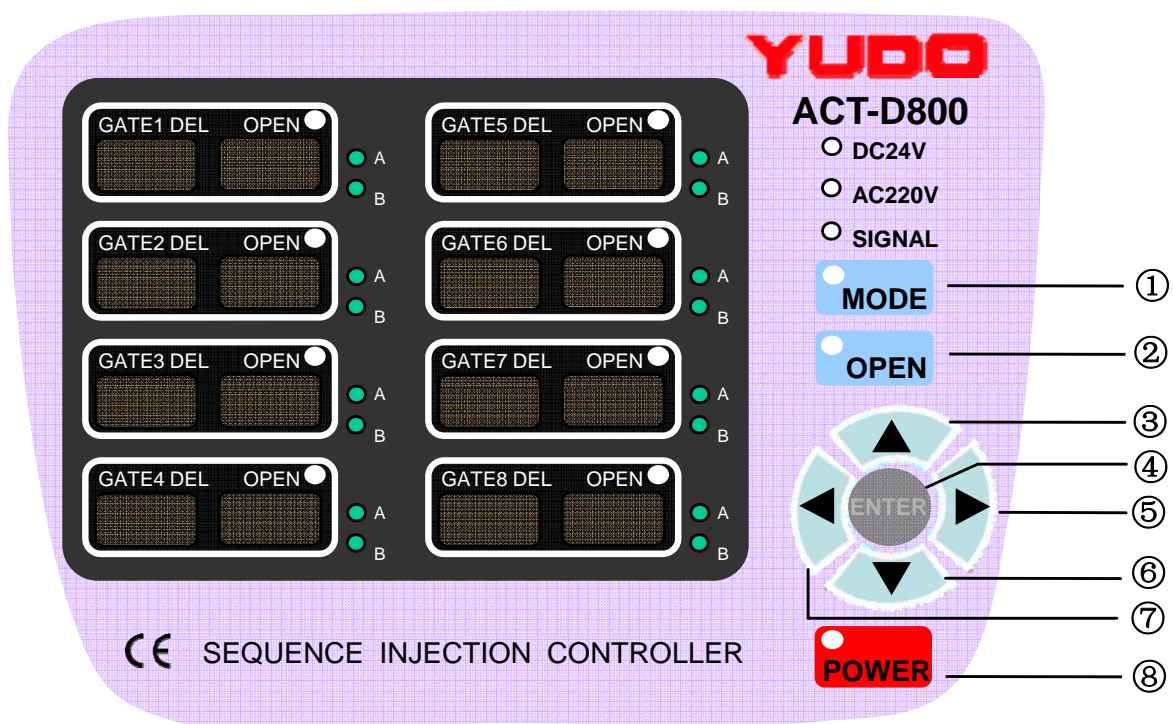
## 4、Input :

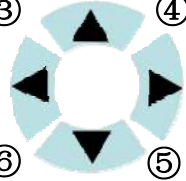

①S.M.P.S: Switching Mode Power Supply

- ① **MODE**
  - a. To select motion mode ( mode A>mode B>gate off) for each gate.  
设定各窗口的动作模式 (MODE A >MODE B>GATE off)时使用。
  - b. To set unit of each gate(999/99.9/9.99).  
设置各GATE的使用单位(999/99.9/9.99)时使用。
- ② **OPEN**
  - a. To open manually a gate or all gate.  
各GATE或者全部GATE以手动OPEN时使用。
- ③ 
  - ④ a. To move to gate for setting.  
设定GATE时, 来回移动时使用。
  - b. To set or to move  
⑤ 设定设置值或移动位置时使用。
- ⑦ 
  - a. To select gate for setting.  
选定要设置的GATE时使用。
  - b. To finalize set or to exit the gate selected.  
完成设置 或者从现在已选定的GATE中退出时使用。
- ⑧ **POWER**
  - a. To turn On/Off time.  
对定时器进行ON/OFF时使用。

## 5、Display 显示因素

- 1) Display delay time and open time of each gate in display panel.  
各GATE的延迟时间和OPEN时间显示在数码管上。
- 2) Display LED on while each gate opens.  
各GATE的OPEN输出期间以LED显示。
- 3) Display MODE A or B of each gate with LED.  
各GATE的MODE A或者 MODE B以LED显示。
- 4) Display output voltage(DC240V or AC220V)to Solenoid Valve with LED.  
以指示灯LED表示螺旋管针阀输出, 输出电压(DC24V或AC220V)。
- 5) Display LED on while signal is on.  
SIGNAL输入时间期间以指示灯LED显示。

## 6、Output 输出因素

- 1) Put out DC24V or AC220V via relay for the open time of each gate.  
各GATE的OPEN输出期间把DC24V或者AC220V通过RELAY接点输出。

## 7、Start to Run 使用说明

### 1) Connect cables

输入及输出电源连接

Connect to main input power, signal input from injection machine, output to mold.

Make sure the main input voltage (see rear of time case), output voltage to mold.

按照时间控制器的电源式样(请参考外壳后部)连接电源线与输入,输出线。

### 2) Power LED is blinking while power on.

输入电源时POWER LED闪灯。

### 3) Switch between actions

工作状态转换

A. Press **POWER** key.

按 **POWER** 键启动电源。

a. POWER LED blinks.

POWER LED 闪灯。

b. Display delay time value and open time value at each display panel.

根据GATE的延迟时间及OPEN时间,把所设置标在GATE上。

### 4) Switch between MODE A/MODE B and gate off.

mode A/ mode B 及窗口off 转换。

A. Press **MODE** for 4 seconds.

按 4 秒左右 **MODE** 键。



a. Buzzer rings and mode LED blinks.

响警告声, MODE LED 闪灯

b. MODE LED of 1st gate blinks.

1号GATE的MODE LED 闪灯

c. Hit  ,  to switch MODE A/B and gate off.

MODE A/B及GATE OFF 的转换是利用  ,  转换。

d. MODE A or B LED blinks, Both MODE A and B LED blink when gate off.

转换时相关MODE A/B 的LED 闪亮, GATE OFF 时MODE A/B全部闪亮。

e. Move using  ,  between GATE.

GATE选择是利用  ,  移动自己需要的GATE。

f. When move, MODE A or B LED is Blinking in the gate.

移动时相关GATE的MODE A或者MODE B LED闪灯。



g. Press  to save, or keep idle for 4 seconds to automatic save.



按  完成设置，位置移动后过4秒后也会自动完成设置。

h. When gate off, all display is off (MODE A/B LED, DEL/OPEN display panel off)  
OFF时, GATE A/B mode LED 和平 DEL/OPEN 表示窗将灭灯。

### 5) Switch between units(999/99.9/9.99)

使用单位的(999/99.9/9.99)转换。

Move the gate using , , and press  for 4 seconds to confirm.



使用方向键盘 ,  选择相关GATE,  换4秒左右。

a. Buzzer rings and MODE LED Blinks.



响警告声，MODE LED 闪灯。

b. “Unl” displays in DEL panel and 999 “or 99.9/9.99” display in OPEN panel.

相关GATE的 LED 显示窗口显示 “Unl”, OPEN显示窗口显示(999/99.9/9.99)。

c. Switch units using ,  .

使用单位变更是利用 ,  变更。

d. Move gate using ,  .

GATE移动是利用 ,  来移动。

e. Hit  to save, or keep idle for 4 seconds to automatic save.

按  完成设置，位置移动后过4秒后也会自动完成设置。

### 6) Manual open

手动OPEN输出

A: ALL OPEN

全部OPEN输出

a. It keep open while  pressed.

按  期间输出OPEN

B: A gate OPEN

只对相关GATE进行OPEN输出。

a. Move using , , ,  to get gate.



利用方向键盘选择GATE

b. It keeps open the gate while  pressed.

按  期间只对相关GATE进行OPEN输出。

## 7) Set DET time:

DET时间设置:

Move using Direction Key to get gate and its DEL panel,  to confirm.  
使用方向键移动到相关GATE的DET显示窗口后按 。

### a. Right digit in DEL panel blinks.

选择的GATE DEL 显示窗口,右边位置的设定值会闪亮。

### b. Set time using , .

时间设置利用 ,  选定。

### c. Move between digits using , .

位数移动是利用 ,  移动。

### d. Hit to save, or keep idle for 4 seconds to automatic save.

按  完成设置,位置移动后过4秒后也会自动完成设置。

## 8) Set OPEN time

OPEN时间设定

Move using , , ,  to get gate and its OPEN panel,  to confirm.

使用方向键移动到相关GATE的OPEN显示窗口后按 。

### a. Right digit in OPEN panel blinks.

在选择的GATE的OPEN显示窗口上,右边位置的设定值会闪亮。

### b. Set time using , .

设定值的变更是利用 ,  选定变更。

### c. Move between digit using , .

移到自己的位置时按 , 。

### d. Hit to save, or keep idle for 4 seconds to automatic save.

按  完成设置,位置移动后过4秒后也会自动完成设置。

## 8、Menu Setting 动态说明

### 1) MODE A 模式A

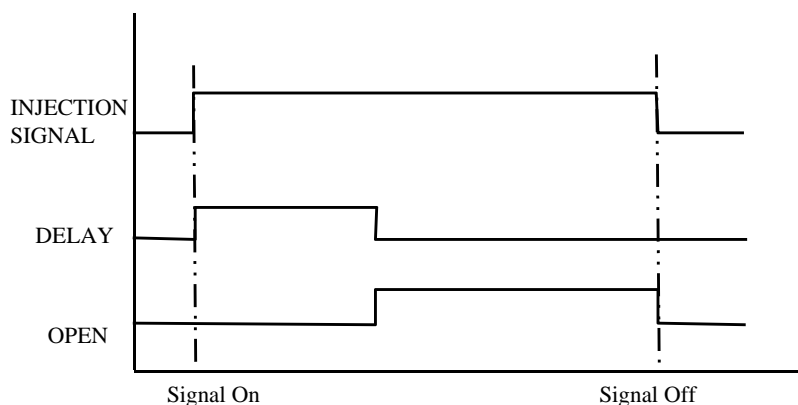

MODE A 动作

i) Example 例如:

a. In case injection signal =10sec and DEL time =4sec, then after DEL time, it opens (Relay ON) for 6sec.

注塑时间: 10秒, DEL 时间: 4秒, 接到注塑信号过4秒后, GATE 以OPEN 状态维持6秒钟后将自动关闭。

b. For the delay time, it counts down and displays it in DEL display panel, and just after DEL time, it opens (Relay ON).

把延迟的DEL时间倒数计秒(Down Count), 标在DEL表示窗口, 在DEL时间完成后开始OPEN输出。

c. In case injection signal is off before delay time passed, it resets to set time.

如在延迟时间结束之前注塑信号先结束, 就开始设定时间初始化。

d. Even after DELAY time passed, injection signal is keeping on, it opens, and it counts up the open time and displays it in OPEN display panel.

如在延迟时间结束之后注塑信号还在继续输入, 就继续输出OPEN。

e. When injection signal is off ,delay set time will be display in DEL display panel, and OPEN display panel displays counted open time until next injection signal comes on.

如注塑信号结束, 延迟设定时间就显示在DEL显示窗口, OPEN在下次注塑信号开始之前一直维持Up Count 的 OPEN 时间, 并将值显示在OPEN显示窗口。

2) MODE B 模式 B

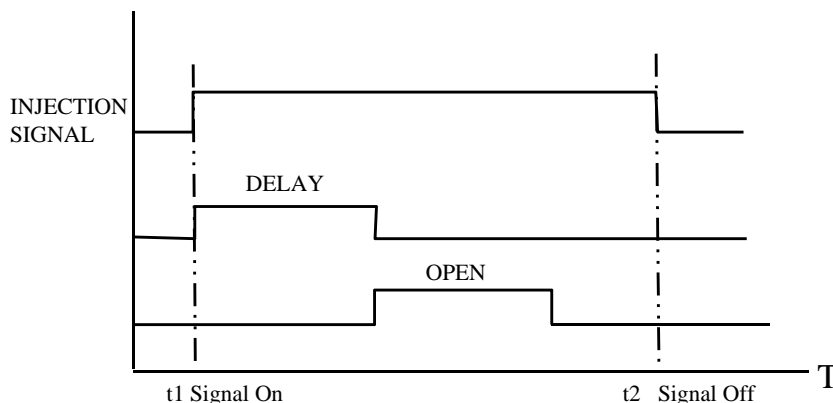

MODE B 动作

Example

a. In case injection signal=10sec, DEL time=4sec, and OPEN time=4sec, then when injection signal comes on, after DEL time, it opens for OPEN time (4sec).

注塑时间:10秒, DEL 时间: 4秒, OPEN时间: 4 秒, 接到注塑信号过4秒后, GATE 以OPEN 状态维持4秒钟后将自动关闭。



- b. For the delay time, it count down and displays it in DEL display panel, and just after DEL time, it opens for OPEN time and it counts down from the OPEN set time and displays it in OPEN display panel.

把延迟的DEL时间倒数计秒, 标在DEL表示窗口, 在DEL时间完成后开始OPEN时间期间, OPEN时间从设定值开始倒数计秒, 并标示在OPEN显示窗口。

- c. In case injection signal is off before delay time passed, it resets to set time.

如在延迟时间或OPEN时间结束之前, 注塑信号先结束, 就开始设定时间初始化。

- d. In case injection signal is off before open time passed, it resets to set time.

OPEN时间终止前注塑信号终止时往设定时间初始化。

- e. When injection signal is off, delay set time and open set time will be displayed DEL display panel and OPEN display panel respectively.

注塑信号结束, 延迟设定时间和OPEN 设定时间, 就标示在DEL 显示窗口和OPEN显示窗口。

### 3) MODE C 模式 C

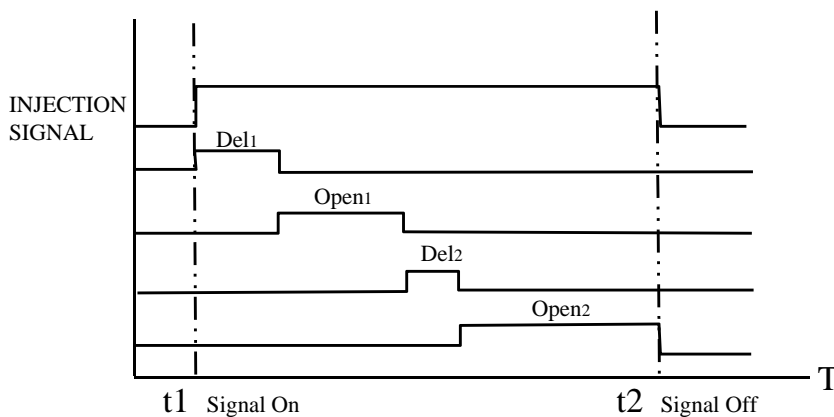

MODE C 动作

#### Example

- a. In case injection signal=10sec, DEL time Del1=2sec, OPEN time Open1=4sec, and Del2=1sec and Open2=4Sec. then when injection signal comes on, after DEL time, it opens for OPEN time (4sec).

注塑时间:10秒, Del1时间: 2秒, Open1时间: 3秒, Del2时间: 1秒, Open2时间:4秒。接到注塑信号过2秒后, GATE 以OPEN 状态维持3秒输出动作自动关闭, 然后保压1秒钟后, GATE 以OPEN 状态维持4秒钟后输出动作将自动关闭。

- b. For the delay time, it count down and displays it in DEL display panel, and just after DEL1 time, it opens for OPEN1 time and it counts down from the OPEN1 set time and displays it in OPEN display panel.

把延迟的DEL1时间倒数计秒, 标在DEL表示窗口, 在DEL1时间完成后开始OPEN1时间, OPEN1时间从设定值开始倒数计秒并标示在OPEN窗口输出动作。在Open时间完成后开始Del2时间, Del2时间从设定值开始倒数计秒, 标在DEL表示窗口。在DEL2时间完成后开始OPEN2时间, OPEN2时间开始倒数, 标在OPEN窗口并输出动作。

- c. In case injection signal is off before delay time passed, it resets to set time.  
如在延迟时间或OPEN时间结束之前, 注塑信号就开始设定时间初始化。
- d. In case injection signal is off before open time passed, it resets to set time.  
OPEN时间终止前注塑信号终止时往设定时间初始化。
- e. When injection signal is off, delay set time and open set time will be displayed  
DEL display panel and OPEN display panel respectively.  
注塑信号结束, 延迟设定时间和OPEN 设定时间, 就标示在DEL 显示窗口和OPEN显示窗口。

### 3) Other Menu

其它显示动态及功能

#### A: Output Voltage Indicator

标出输出电压

- a. Select output voltage DC24V or AC220V in compliance with Solenoid valve.  
输出电压是根据螺旋管针阀可选DC24V或者AC220V。
- b. Display output voltage in DC24V LED or AC220V LED.  
输出电压是根据螺旋管针阀可选DC24V或者AC220V。

#### B: Input ON/OFF Indicator

输入ON/OFF 标示

- a. When input is on, SIGNAL LED is on.  
输入ON/OFF 标示
- b. When input is off, SIGNAL LED is off.  
输入OFF-SIGNAL LED 关闭。

## 9、 Mode Specification

### ◆Mode A

Selecting mode A: After the injection signal has been received, the gate is continuously closed during the DEL Time( $t_1$ ), After the DEL time has elapsed, the gate Opens and will remain opened until the end of the injection signal.

选择模式A: 接收到注塑信号后, 在延迟时间内, 浇口是关闭的, 在(Del时间)消失后, 浇口打开且一直保持开着状态, 直到注塑时间信号结束。

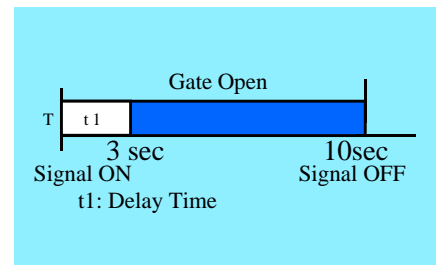

## ◆ Mode B

Selecting mode B: After the injection signal has been received, the gate is closed during the DEL time ( $t_1$ ). After the DEL time has elapsed, the gate is opened for the OPEN time ( $t_2$ ). After the OPEN time has elapsed, the gate will be closed.

选择模式B: 当一收到注塑机信号后, 在延迟时间内 $T_1$ , 浇口一直关闭, 延迟时间消失后, 浇口打开(按设定的打开时间 $T_2$ )。在浇口开放时间(OOPEN时间)消失后, 浇口开始关闭, 且保持关闭。

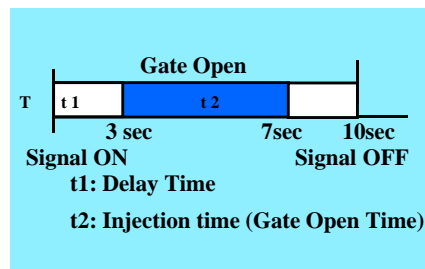

## ◆ Mode C

Selecting mode C: After the injection signal has been received, the gate is closed during the DEL time ( $t_1$ ). After the DEL time( $t_1$ ) has elapsed, the gate is opened for the OPEN time ( $t_2$ ). After the OPEN time( $t_2$ ) has elapsed, the gate is closed during the DEL time ( $t_3$ ). After the DEL time( $t_3$ ) has elapsed, the gate Opens and will remain opened until the end of the injection signal.

选择模式C: 当一收到注塑机信号后, 在延迟时间内 $t_1$ , 浇口一直关闭, 延迟时间消失后, 浇口打开(按设定的打开时间 $t_2$ );在浇口开放时间(OOPEN时间 $t_2$ )消失后, 浇口在延迟时间 $t_3$ 内一直关闭, 延迟时间 $t_3$ 结束后, 浇口打开且在 $t_4$ 时间内一直保持开着状态,直到注塑时间信号结束。

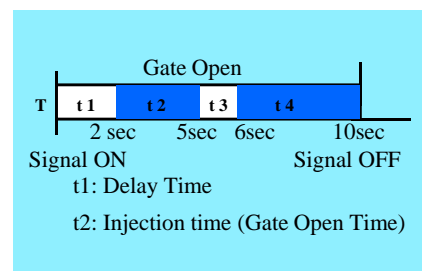

## ◆ Gate Opening by Mode Type Selection

### 模式选择打开浇口

It is possible to set various conditions by selecting the DEL and OPEN timer setting as below.

尽可能通过选择延迟时间 (DEL键) 和开放时间 (OPEN键) 来设定不同的注塑时间控制条件, 如下所示:

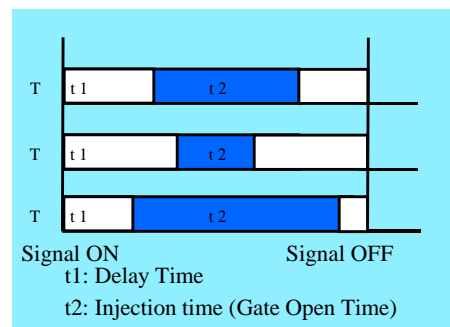
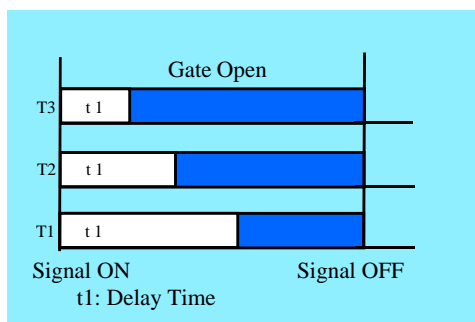

## 10、System Applications

### ◆Application for Mode A

①In case that short molding occurs at the extreme of the product.

Open the gate A to fill the major portion of the molded part, and then open the gate B to fill the short molded area of the component.

①如图所示，胶未填充的地方往往发生在产品的极端部位。首先浇口A填充好成形的大部分，然后浇口B填充胶未注射到的部位。

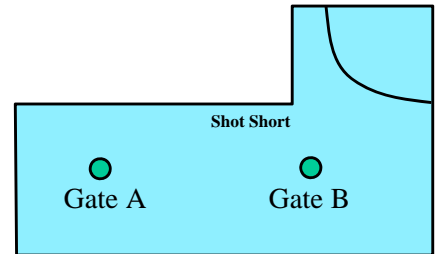

②In case that there is a wide difference in the molding area of the component.

Firstly, open the gate A where the molding area is large in order to fill this section precisely, and then open the gate B to fill the small area.

Adjusting flow balance by the gate open time will ensure that the component is filled evenly.

②如图所示，在产品的成形区域有很大的差别。位于较大区域的浇口A首先打开，目的是为了精确的注满这部分，然后，浇口B打开填充其较小注射区域。通过控制浇口的开放时间，调节流道的平衡，以确保产品能被均匀的注射满。

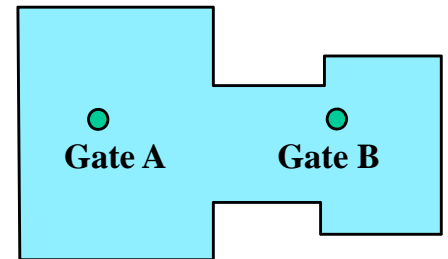

### ◆Application for Mode B

In case that there is a wide difference in area due to a complicated molding product. Apply mode A for gate A~D and Mode B for gate E.

Using this sequence will enable the gate feeding the very small area to be closed before the injection ends. 如图所示，由于产品成形的复杂性，每个浇口所成形的区域面积有很大的差异。运用模式A控制浇口A~D，模式B控制浇口E。使用时间控制器能确保浇口在注射结束关闭时，填充其最小区域。

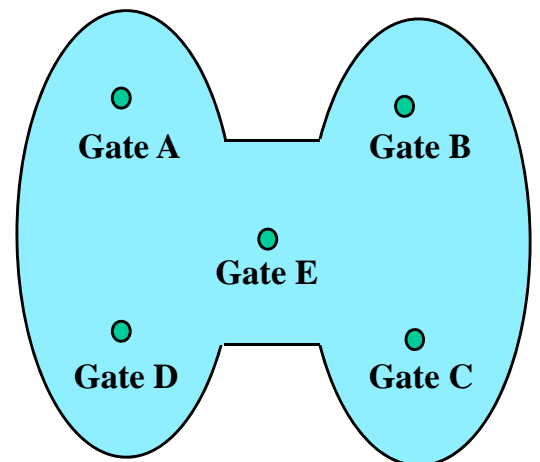

## 11、Wiring Specification 外部接线连接图

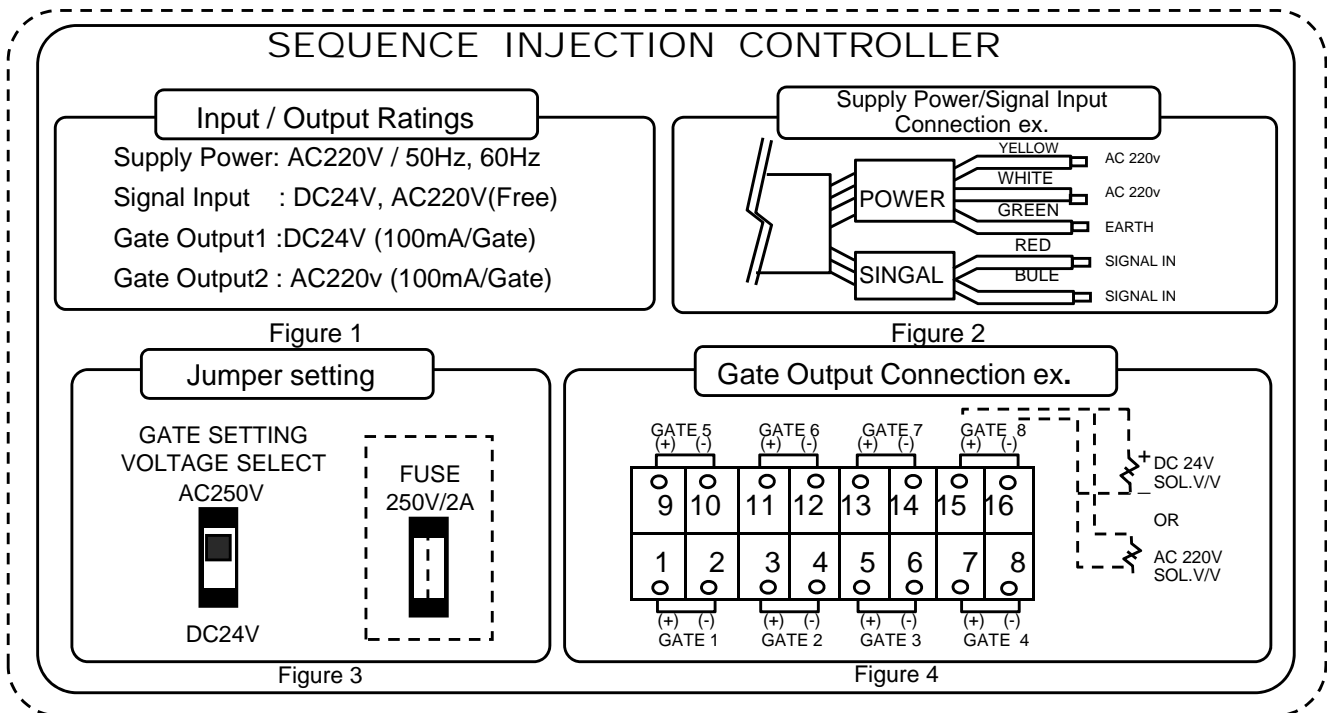

### 1) Power Input Connection

连接输入电源

Connect POWER-BLACK and POWER-WHITE to AC220V(Figure2)and earth POWER\_GREEN line.

如图2POWER-BLACK线和POWER-WHITE 线连接在AC220V电源POWER\_GREEN线与地线连接。

### 2) Signal Input Connection

连接输入信号

Connect SIGNAL GREED and SIGNAL BLUE to SIGNAL INJECTION.

如图2 SIGNAL-RED线与SIGNAL-BLUE线连接在注塑机的INJECTION信号输出。

### 3) GATE Output Connection

输出信号连接

Connect Solenoid Valve as referred to figure 4.

Caution: Use the same electric poles using DC24V Solenoid Valve connection.

如图4 连接螺旋管针阀 (SOLENOIDE VALVE)

注意: 使用有电极的DC24V针阀时,如上图正确连接。

### 4) Gate Output Voltage Select

输出电压选择

Jumper Setting is located on the back of ACST-600 (Figure 3).

Connect AC220V using AC220V Solenoid Valve and DC24V Solenoid Valve to DC24V.

分离ACST600背面,可以看到如图3所示的JUMPER SETTING 的排列,使用AC220V螺旋管针阀时把连接外壳与AC220V连接,用DC24V螺旋管针阀时把连接外壳与DC24V连接



CE  
ISO9001: 2000

**YUDO**®

## MENO

# YUDO®

---

**YUDO (CHINA) CO., LTD.** 柳道实业有限公司

TEL:852-23445180

FAX:852-23445018

E-MAIL: [info@yudohotrunner.com.hk](mailto:info@yudohotrunner.com.hk)

**YUDO TRADING CO., LTD.** 东莞市柳道贸易有限公司

TEL:86-769-85394466

FAX:852-769-85394455

E-MAIL: [yudo@changan.net](mailto:yudo@changan.net)

**YUDO WANCO (SHUZHOU) CO., LTD.** 柳道万和(苏州)热流道系统有限公司

TEL:86-512-65048882

FAX:86-512-65046886

E-MAIL: [suzhou@yudowanco.com](mailto:suzhou@yudowanco.com)

**YUDO WANCO (SHANGHAI) OFFICE** 柳道万和(青岛)办事处

TEL:86-21-50593818

FAX:852-21-68556363

E-MAIL: [shanghai@yudowanco.com](mailto:shanghai@yudowanco.com)

We reserve the right to change specification without notice.

在不预先通知下，我们保留修改变更的权利。